

BurdaMedia Extra

Technical Specifications for the Receipt of Advertising Materials and Detailed Instructions for PDF Preparation

Phone:

00420 221 589 111

Please send the data to the contact address:

inzeraty@burda.cz or to a designated person

Send proofs to the address:

BurdaMedia Extra (Advertising Coordination)

Přemyslovská 43, *Luxembourg Plaza*

Prague 3 130 00

Apetit.....	Mobile: +420 737 696 666, klara.buresova@burda.cz
Burda.....	Mobile: +420 602 455 493, ilona.simakova@burda.cz
Elle.....	Mobile: +420 724 369 165, kristyna.reznickova@burda.cz
Elle Decoration.....	Mobile: +420 731 421 775, petra.paleckova@burda.cz
Marianne.....	Mobile: +420 730 574 142, barbora.gregrova@burda.cz
Marianne Bydlení.....	Mobile: +420 731 421 775, petra.paleckova@burda.cz
Marianne Venkov a styl.....	Mobile: +420 731 421 775, petra.paleckova@burda.cz
Svět ženy.....	Mobile: +420 730 574 142, barbora.gregrova@burda.cz
Naše krásná zahrada.....	Mobile: +420 731 421 775, petra.paleckova@burda.cz
Chip.....	Mobile: +420 737 700 077, anezka.cestrova@burda.cz
Křížovky.....	Mobile: +420 602 455 493, ilona.simakova@burda.cz

1. Data Reception

We accept printing data via email at inzeraty@burda.cz.

In the subject line, please include the magazine name, issue number, release date, and the client's name.

For larger data files, please send them as a link through services designed for data sending, such as WeTransfer.

2. Proofs

Certified digital proofs as a color reference must be provided with the printing data.

Send proofs to the address:

BurdaMedia Extra, Luxembourg Plaza, Přemyslovská 43, Prague 3 (Advertising Coordination)

There are two color printing profiles: For inner pages, Fogra 45 (*PSO LWC Improved ECI*), and for the cover pages, Fogra 39 (*Coated Fogra 39*).

Failure to provide such a proof along with the data will result in the immediate forfeiture of the right to claim for technical quality of printing and color accuracy of the advertisement.

3. Technical Specifications

- a)** We only accept data in **PDF format, version 1.6** or higher. (*No JPEG or Corel Draw.*)
Remember to save PDFs in at least version 1.6. This is so crucial we're mentioning it twice.
Exporting from CC versions released after June 2023, as PDFs in lower versions may contain errors that cause crashes on our RIPs..
- b)** PDFs must be in CMYK color space, **MUST NOT contain spot colors, RGB, LAB.**
- c)** **Do not embed ICC profiles** in the PDF. (*See image attachment.*)
All ICC profiles are automatically removed by our system and by the printing companies we work with, leading to potential changes in color. Consequently, you will need to re-approve such modified data via email.
- d)** Keep font size above 5 points, negative font size above 9. Smaller sizes are not legible.
- e)** Important graphics should be placed at least 6 mm from the page cut, especially logos. Pay particular attention where the graphics will go into the binding, usually on the left.
Thus, remember that (*usually*) the left part of your visual will go into the spine, and you should give it a larger margin from the left edge of the page.
- f)** We recommend outlining all texts. If not, all fonts must be embedded in the PDF. (*See image attachment.*)
- g)** If you are preparing a double-page advertisement, split it into two pages. Each page must be a separate page in the PDF.
- h)** Remember crop marks and a bleed of 5 mm.
- i)** Again, regarding the double-page spread. (*See image attachment.*)
Imagine an open magazine. To see continuity in the image between pages, you would need to perfectly open the magazine, and even then, the image would not align due to part of it being glued into the spine. Therefore, it's advisable to offset the image by 3 mm to the left and right from the spine, creating a non-aligning gap between the left and right pages. This gap will compensate for the image's adhesion in the spine after printing (and binding). Likewise, remember that this applies to all continuing graphics. Therefore, if you have a headline crossing from the left to the right side, you need to create a slightly larger space at the transitions over the spine. However, the degree of adhesion varies depending on the place in the magazine, so we must agree on a compromise, which universally in the industry is considered to be 3 mm on each side; thus, a total difference of 6 mm.
- j)** The absolute basics are image resolution. (*See image attachment.*)
The standard is 300 DPI at 100% size. Lower resolution leads to a perception of blurriness. Images under 200 DPI will be returned to you, or we will require explicit consent for their printing. Please also remember that enlarging a high-res image in Indesign by 200% results in a low-res outcome.
- k)** If we request data adjustments from you, you are not entitled to invoice for additional costs.

Full Page:

bleed size = trim size + 5 mm (which will be trimmed off)

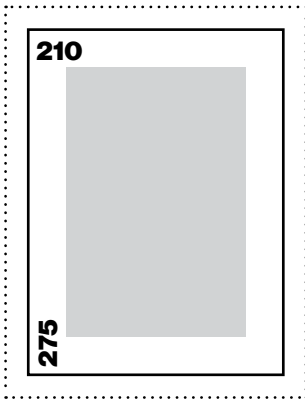

trim size: 210x275 mm

Double Page Spread:

bleed size = trim size + 5 mm (which will be trimmed off)

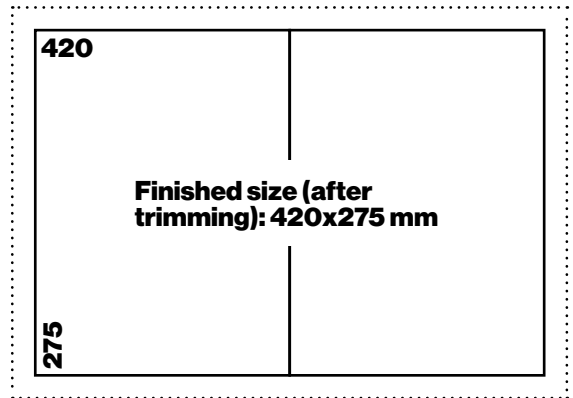

Data for a double-page spread must be provided as single pages.

For the magazine Our Beautiful Garden, we sew the pages into V1 binding, which means that the pages are not glued together at the spine, so there is no need to work with indentation.

1/2 page

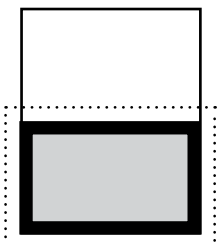

trim size
210x135

1/2 page

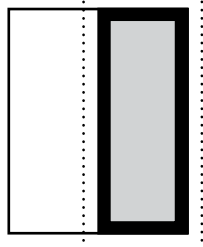

trim size
104x275

1/3 page

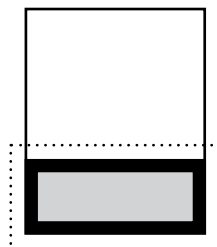

trim size
210x90

1/3 page

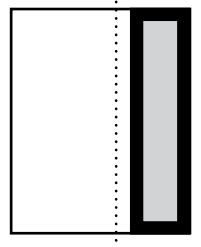

trim size
72x275

1/4 page

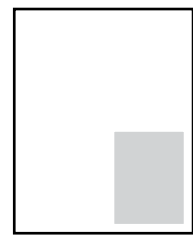

type size
85x118

1/4 page

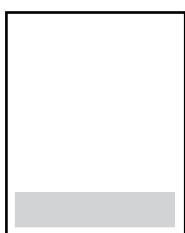

type size
175x56

1/6 page

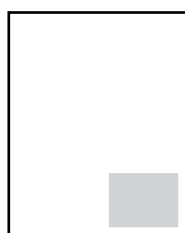

type size
85x76

junior page

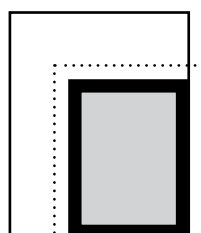

trim size
135x210

BurdaMedia Extra

Image Attachment
and Detailed Instructions for PDF
Preparation

Color Settings in InDesign and Photoshop

There are two printing standards we use for printing. The interior pages of magazines are adjusted according to the Fogra 45 standard (PSO LWC Improved), and the Fogra 39 standard (Coated Fogra 39) is used for printing front pages, covers, on glossy coated paper.

It is essential that images prepared in Photoshop are in these specific color spaces. However, these ICC profiles are only used as a space for coloring images and are not embedded into PDFs. See the following pages for export details.

First, check your Photoshop settings and then ensure that all images are correctly colored in the appropriate print profile.

Photoshop Color Settings

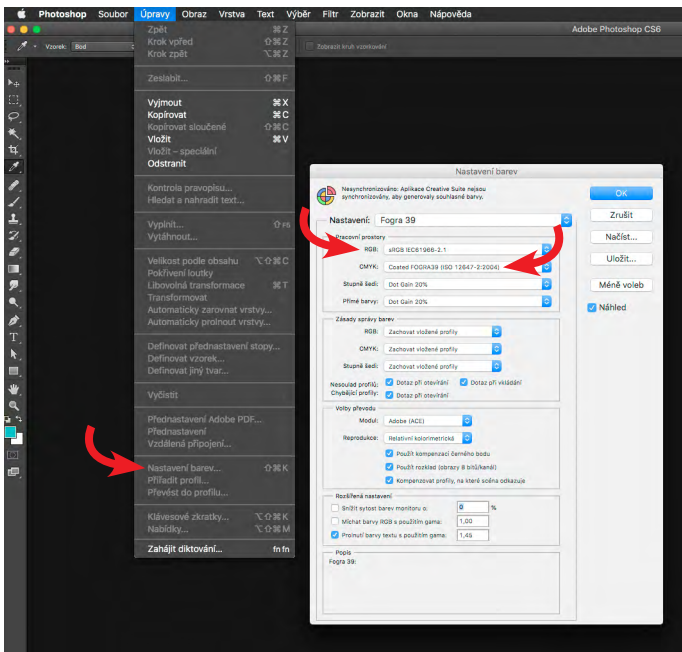

Assign Profile

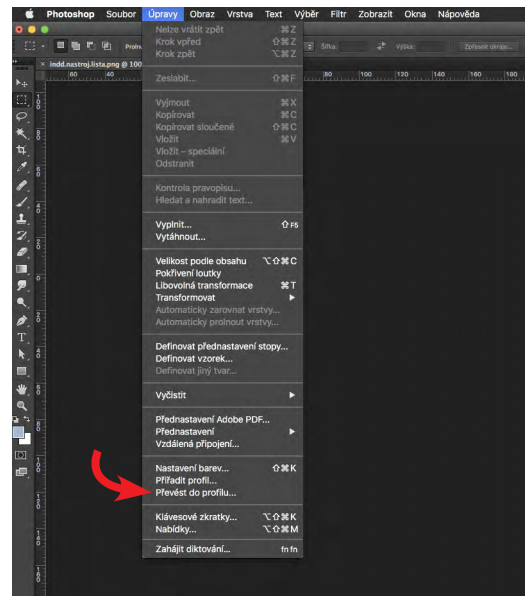

cover Fogra 39

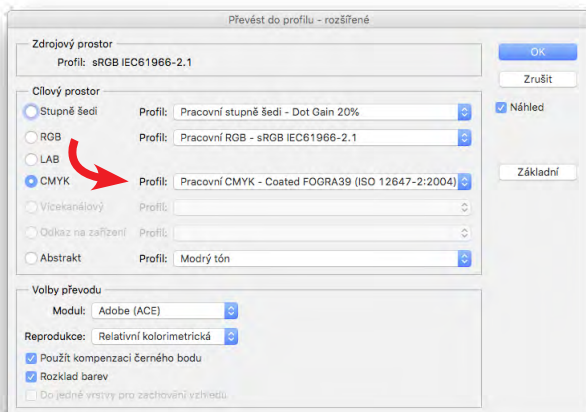

interior pages Fogra 45

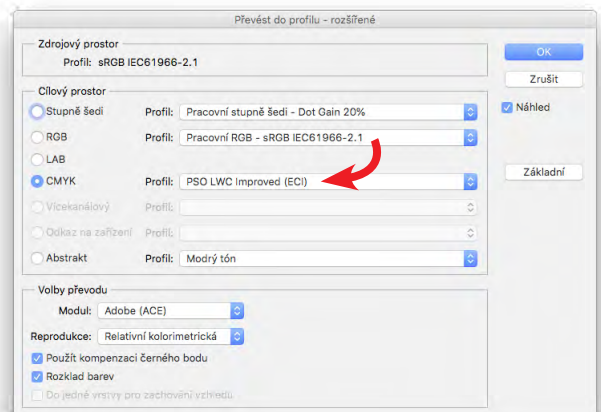
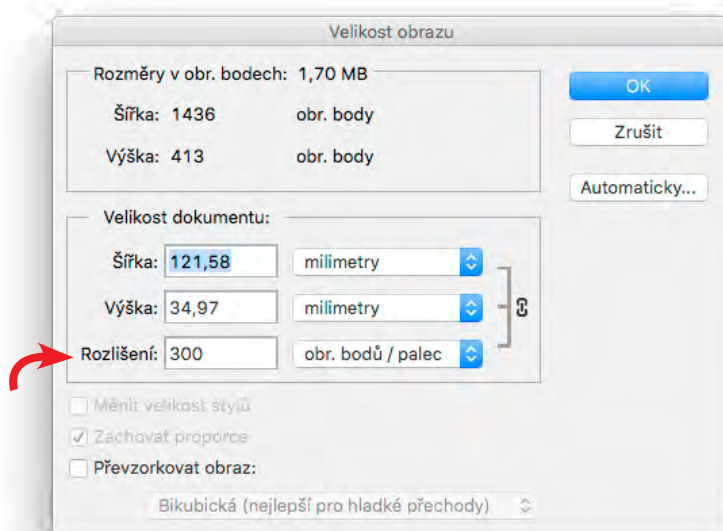
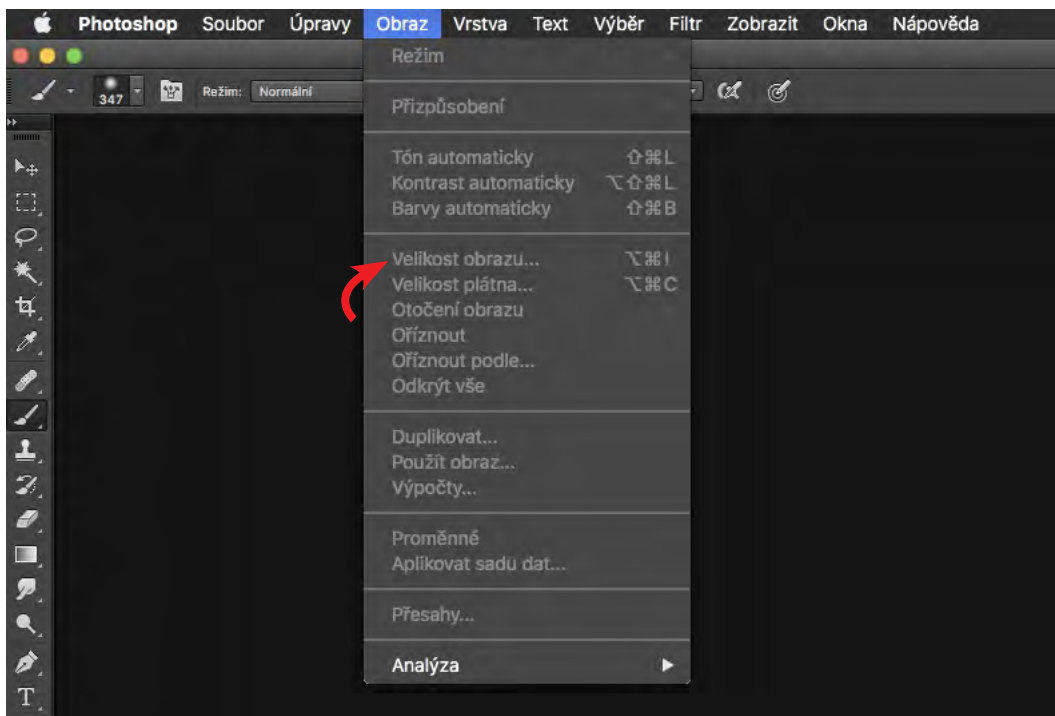

Image Resolution Settings in InDesign and Photoshop

The fundamental quality of the data received is the resolution of images. For print materials, a resolution of 300 DPI at 100% size is generally considered sufficient. This means that it's not only important for an image in Photoshop to have the correct resolution set, but also that the size of the image remains at 100% or less in other programs.



InDesign Tool Panel



Export of Print Data (Adobe Indesign + Illustrator)

In June 2023, Adobe released an update for the Adobe PDF libraries. This update causes an error in PDFs when images are compressed using ZIP. To avoid this issue, we suggest following our detailed guide on exporting from any version of InDesign or Illustrator.

1.

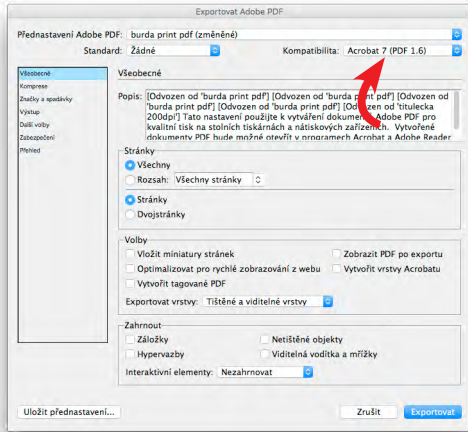

2.

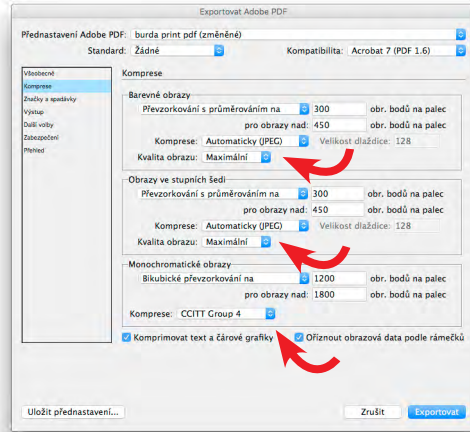

3.

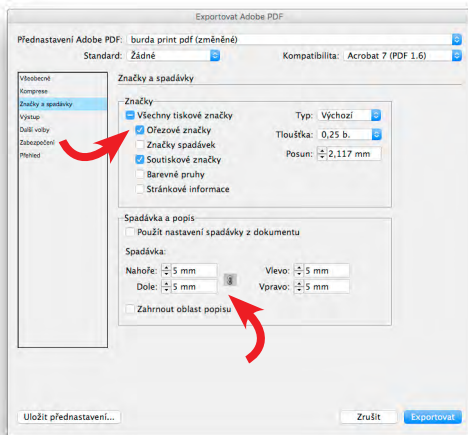

4.

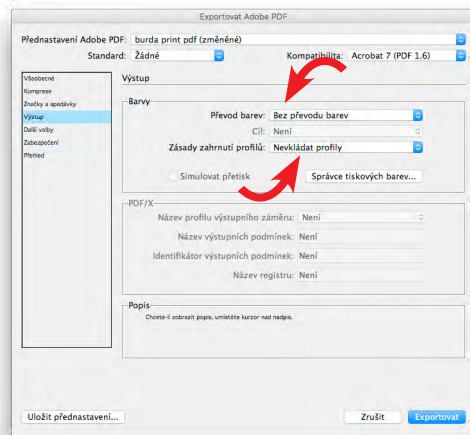

5.

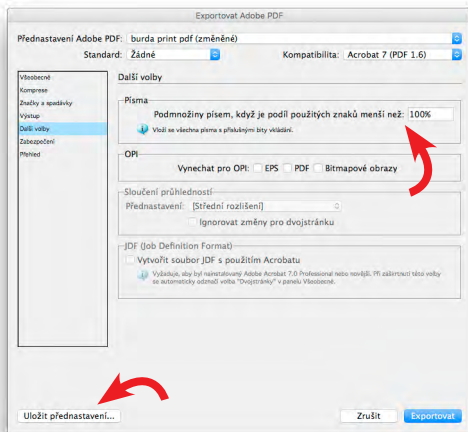

6.

